

row: 1, col: 1

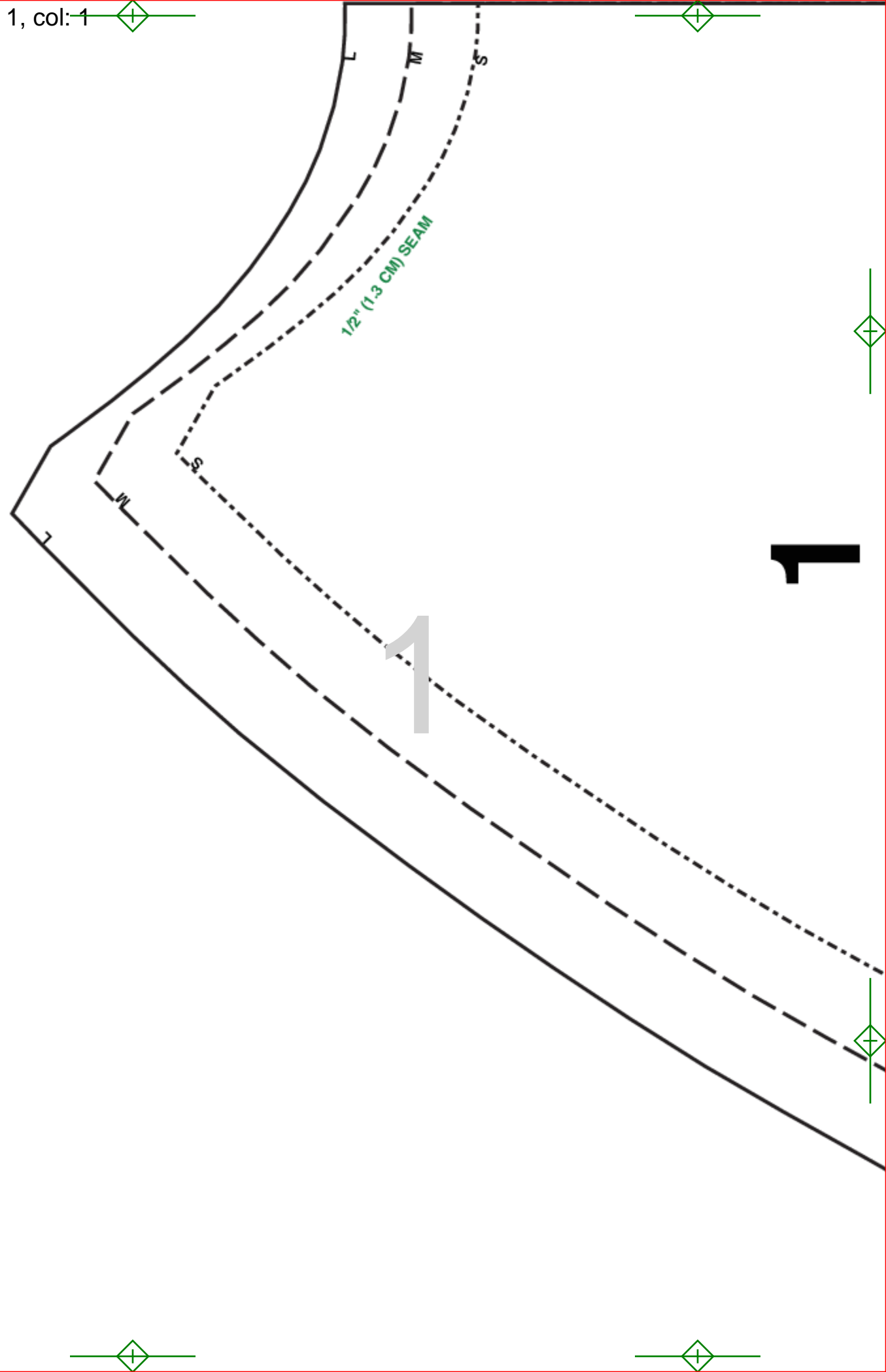

FRONT
DEVANT
FRENTE
VORDERTEIL
DAVANTI

Cut 1 on fold

McCall's

@2020 a CSS Industries, Inc. Brand
All Rights Reserved
Printed in U.S.A.

M 8170

Men's Sizes A (S-M-L)



S 51" (130CM)
M 55" (140CM)
L 59" (151CM)



L 59" (151CM)

LENGTHEN OR SHORTEN HERE

3

WAISTLINE



row: 1, col: 4



4





5





6



7

HEM 1 1/4" (3.2 CM)

LENGTHEN OR SHORTEN HERE





8



9

3

SLEEVE
MANCHE
MANGA
ÄRMEL
MANICA

Cut 2

McCall's

M 8170

Men's Sizes A (S-M-L)

L

M

S

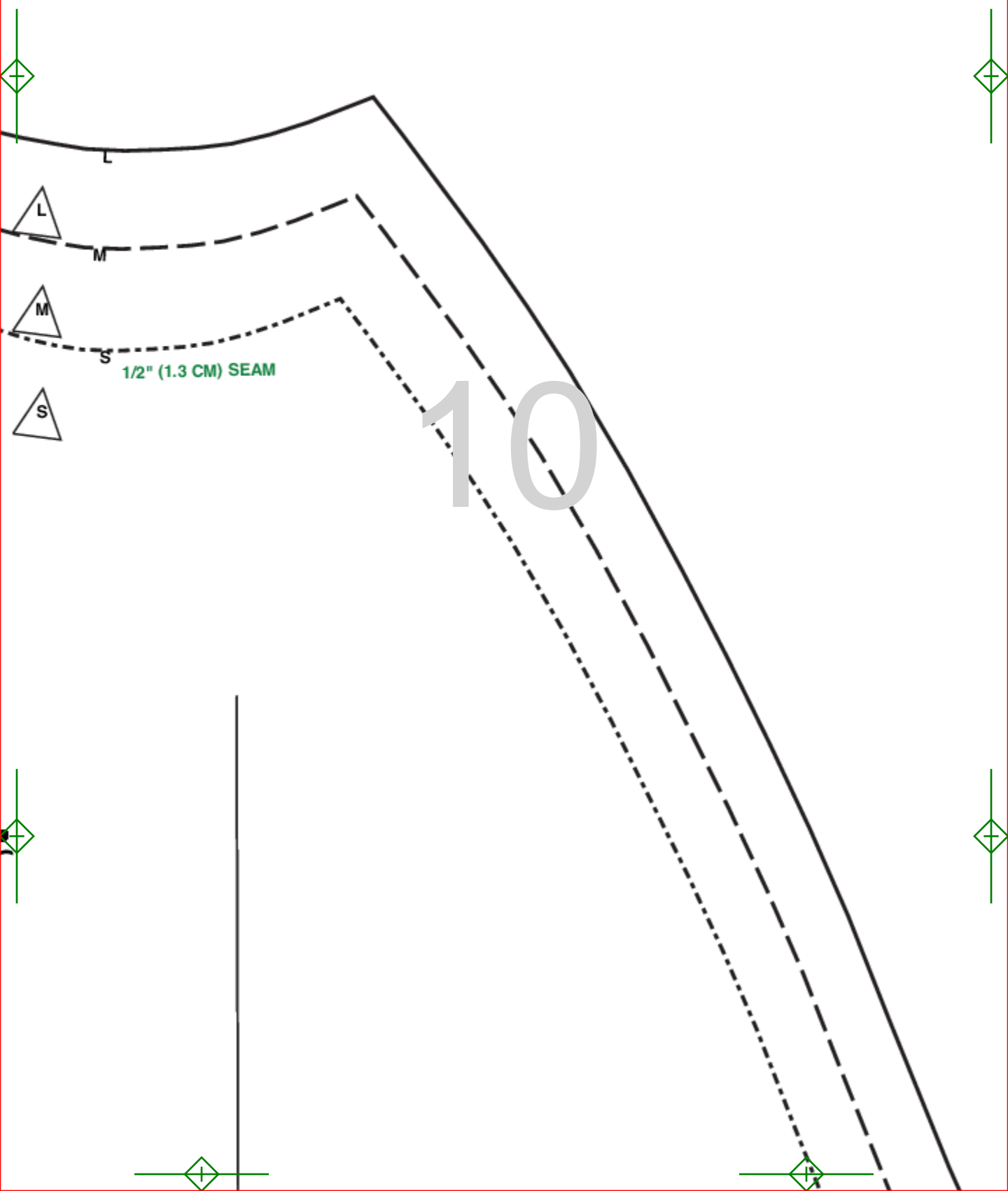

1/2" (1.3 CM) SEAM

10



11





12





13



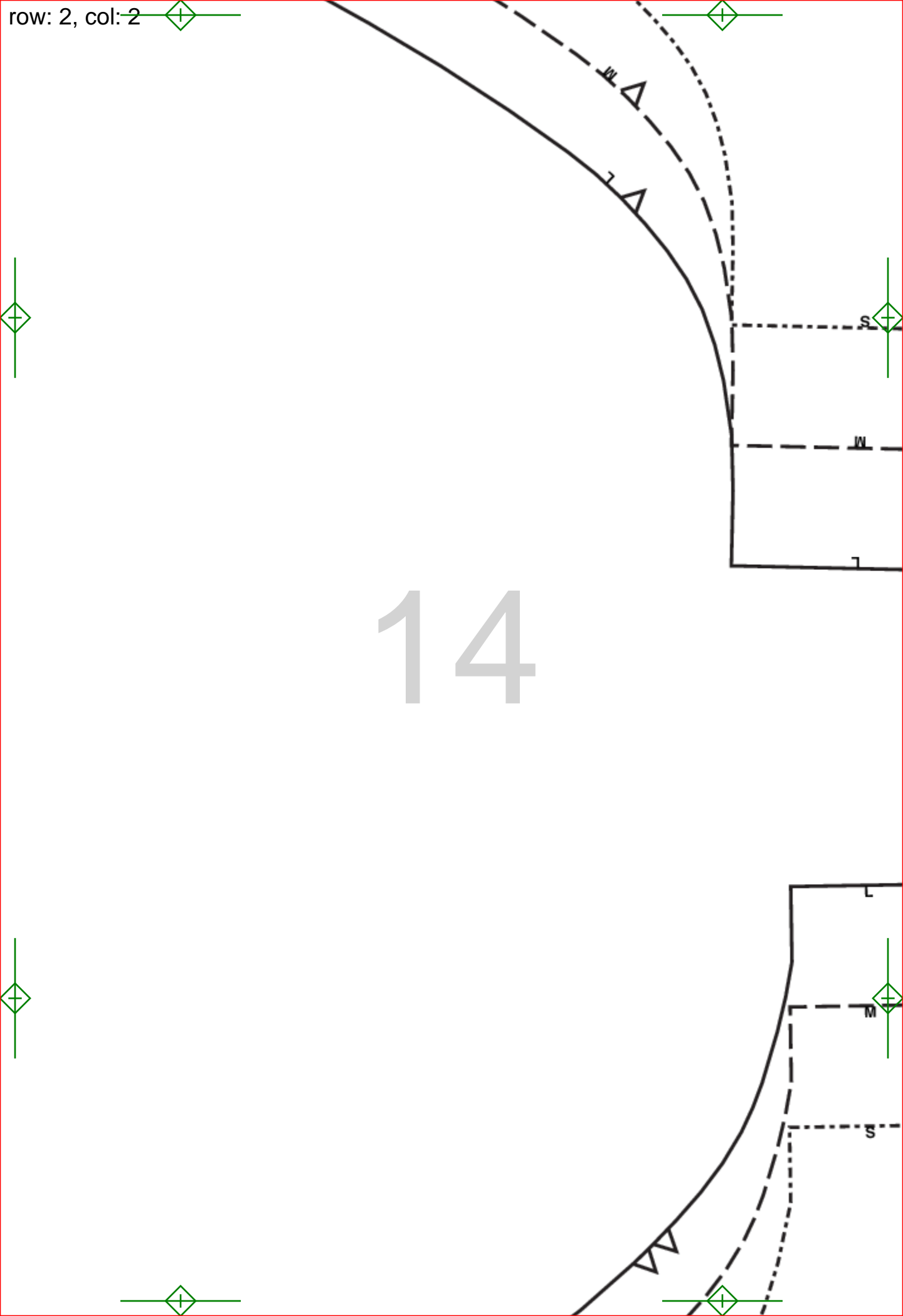

14

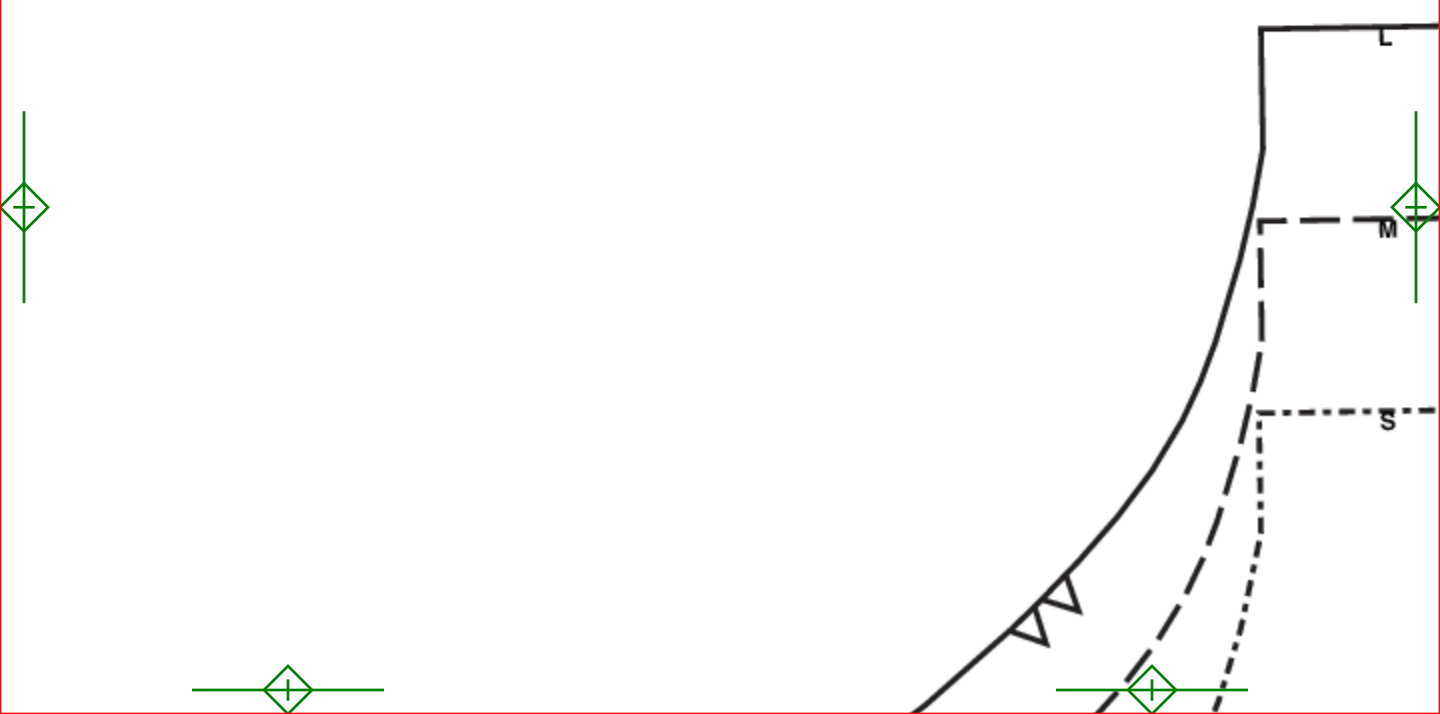

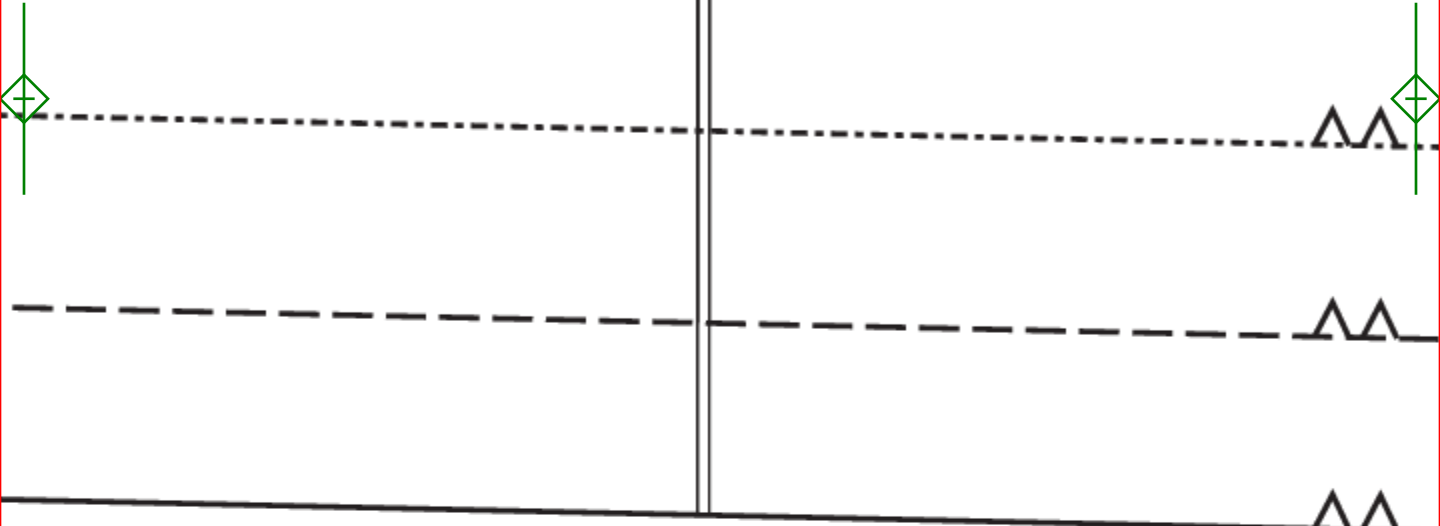

15

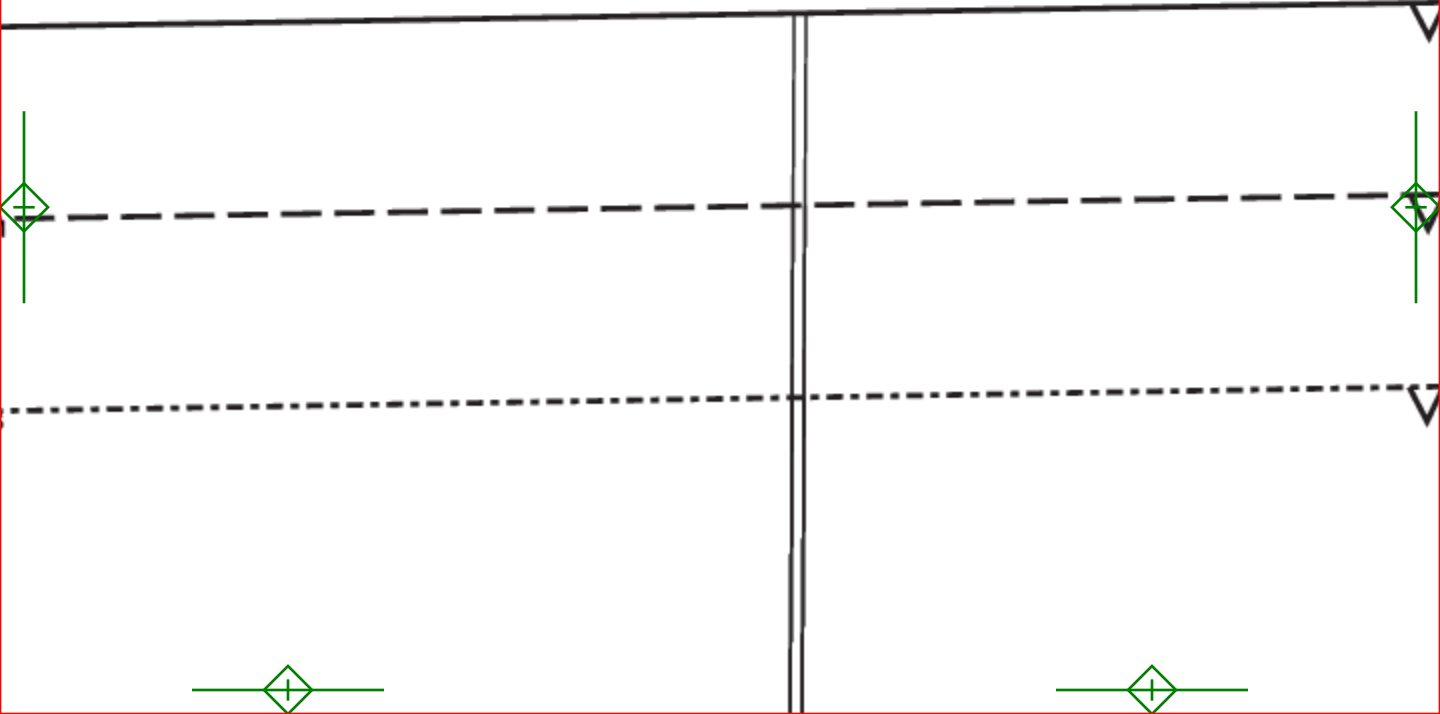

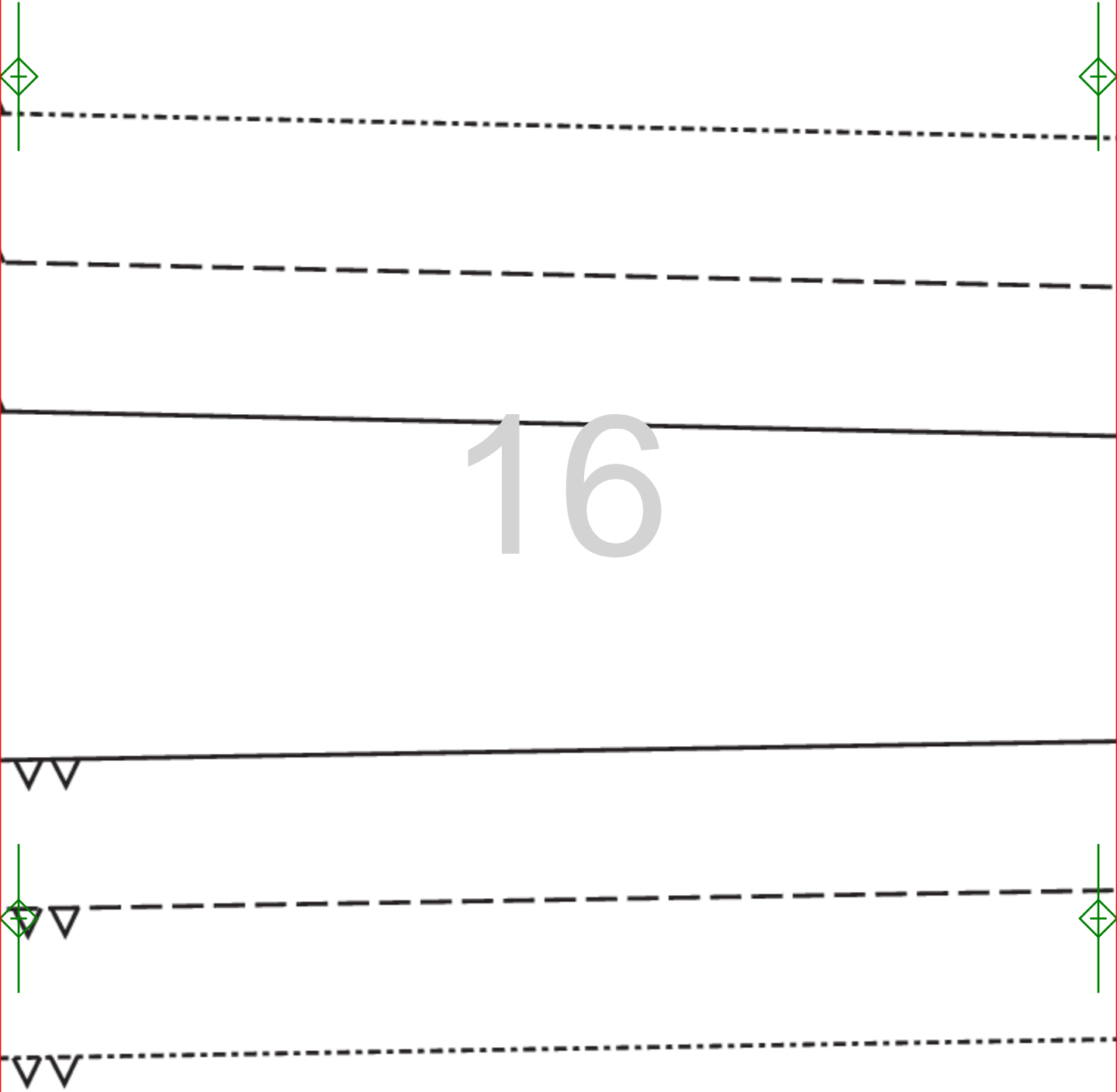

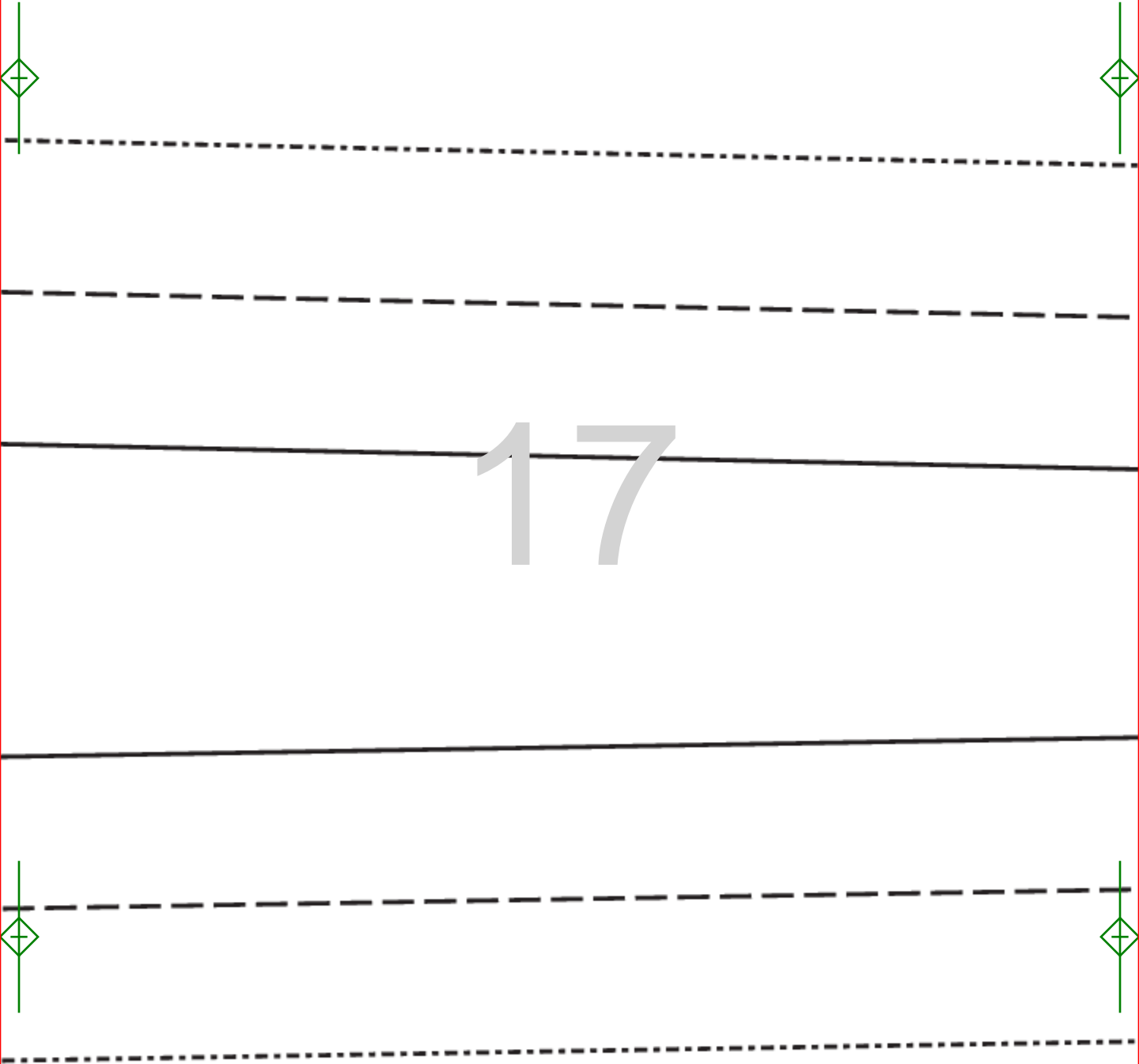

17





18



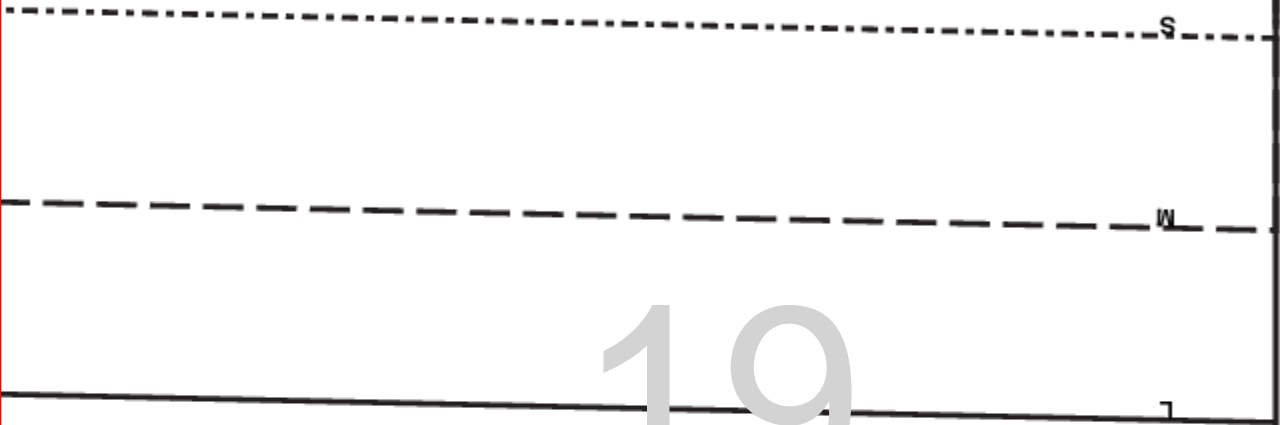

19

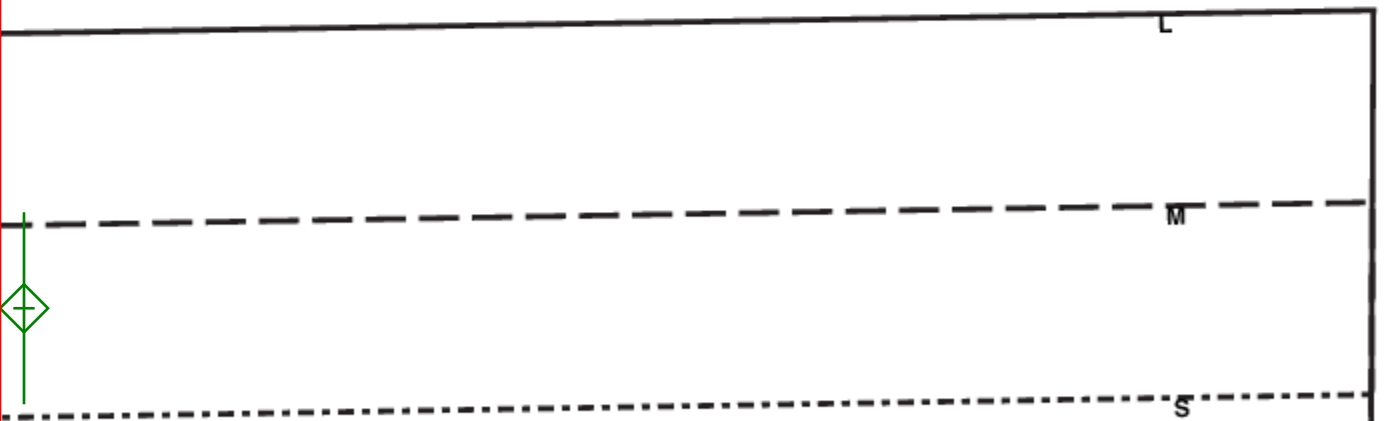

20

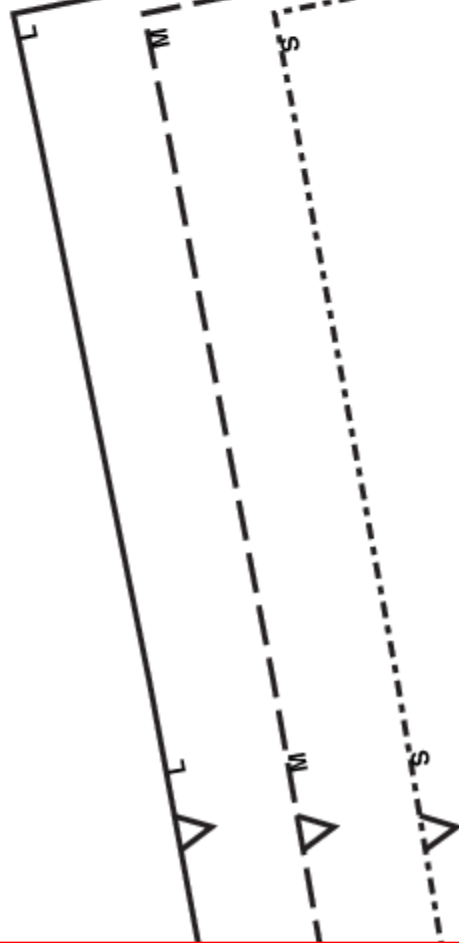

row. 2, col: 9

21

S 21" (530mm)
M 21 1/2" (546mm)
L 22" (559mm)

GRAINLINE

22



(53CM)
1/2" (54CM)
(56CM)

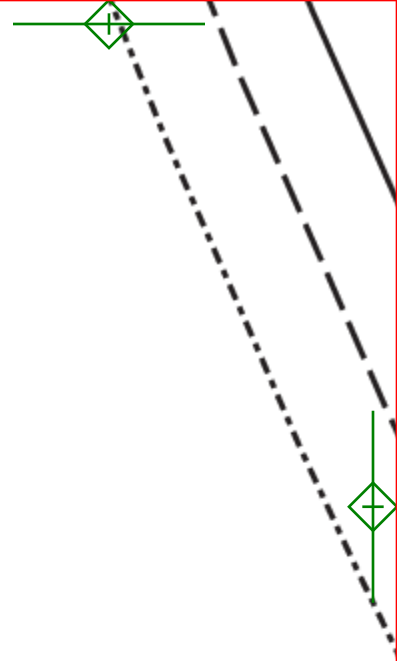

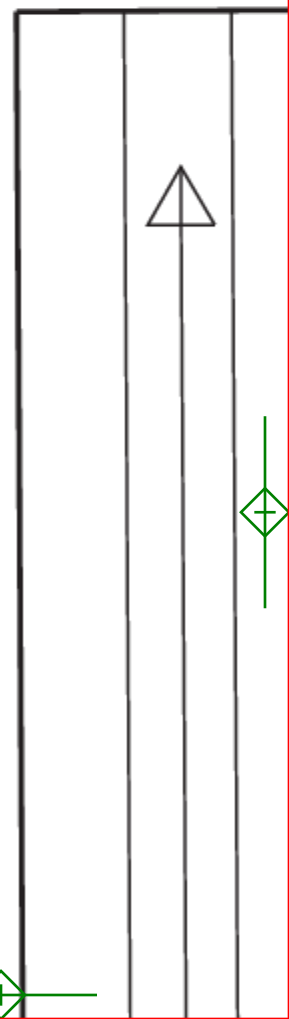
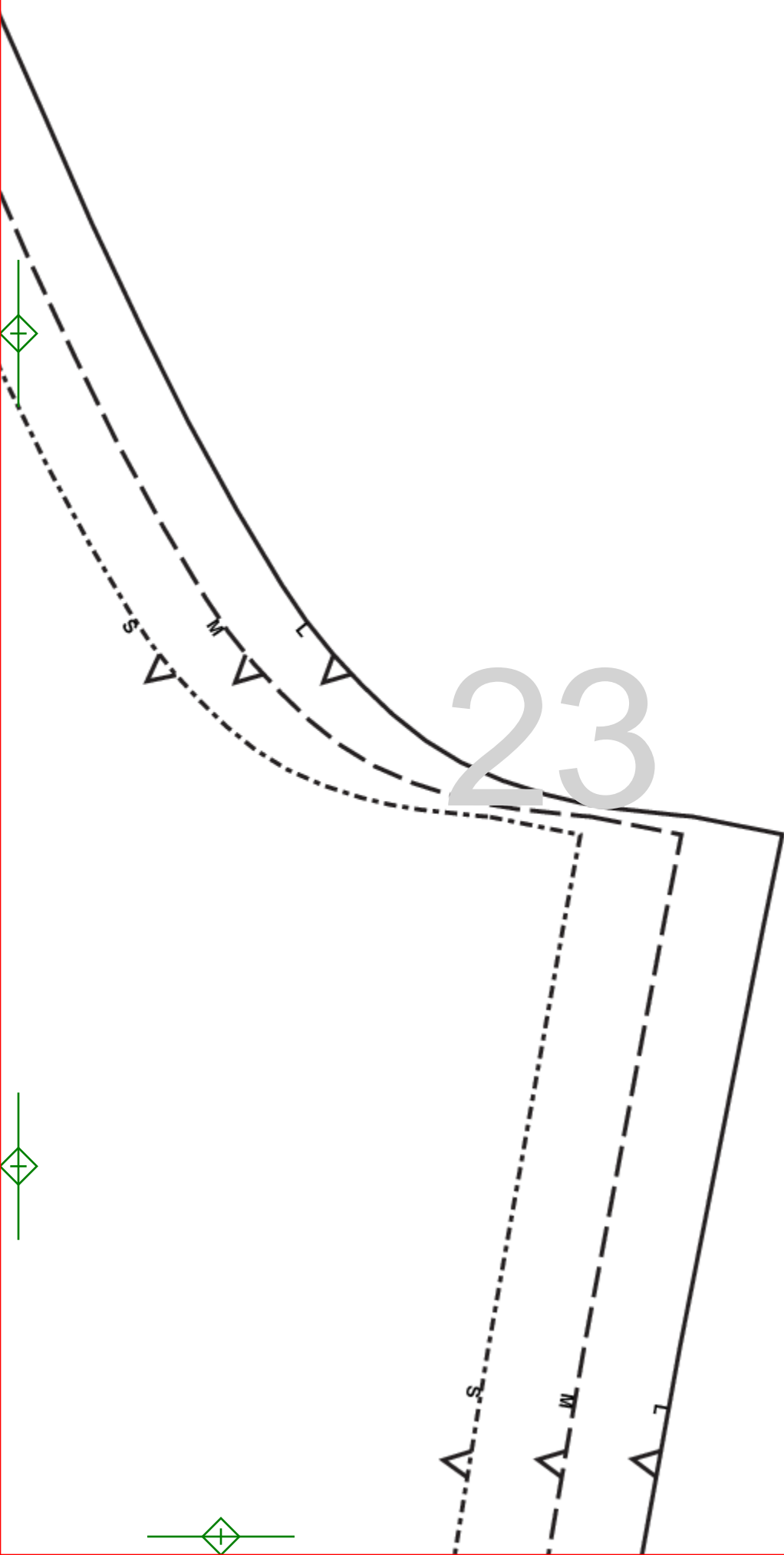

23



24

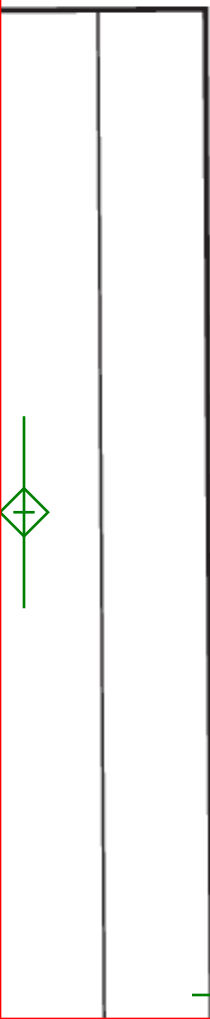

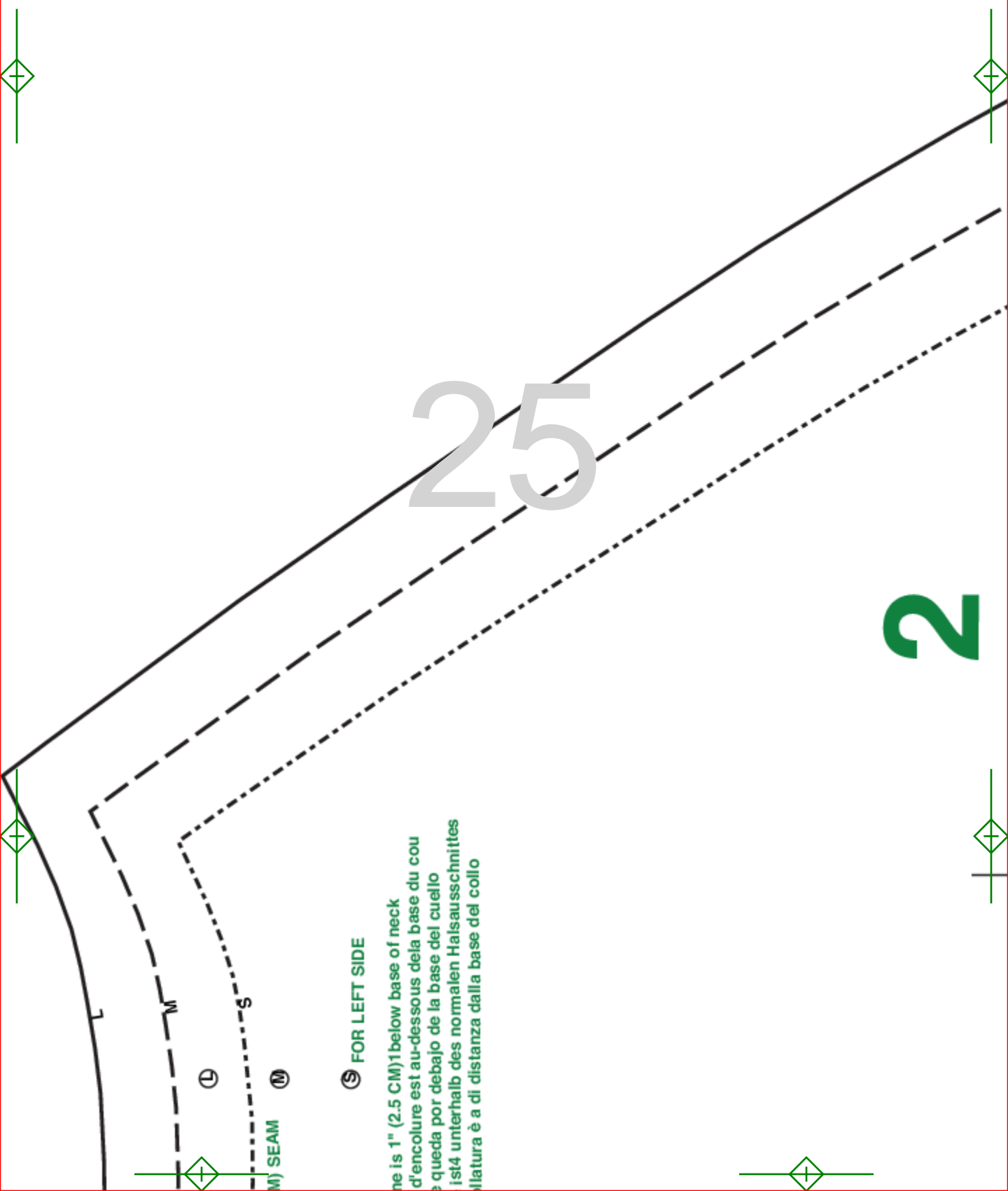

25

2

L

M

M) SEAM

S FOR LEFT SIDE

ne is 1" (2.5 CM) below base of neck
 d'encolure est au-dessous de la base du cou
 e queda por debajo de la base del cuello
 ist4 unterhalb des normalen Halsausschnittes
 Matura è a di distanza dalla base del collo

BACK
DOS
ESPALDA
RÜCKENTEIL
DIETRO

Cut 2

McCall's
M8170
Men's Sizes A (S-M-L)

GRAINLINE

Ⓛ Ⓜ Ⓢ

FOR LEFT SIDE
POUR COTE GAUCHE
PARA COSTADO IZQUIERDO
FÜR LINKE SEITE
PER LATO SINISTRO

Ⓛ Ⓜ

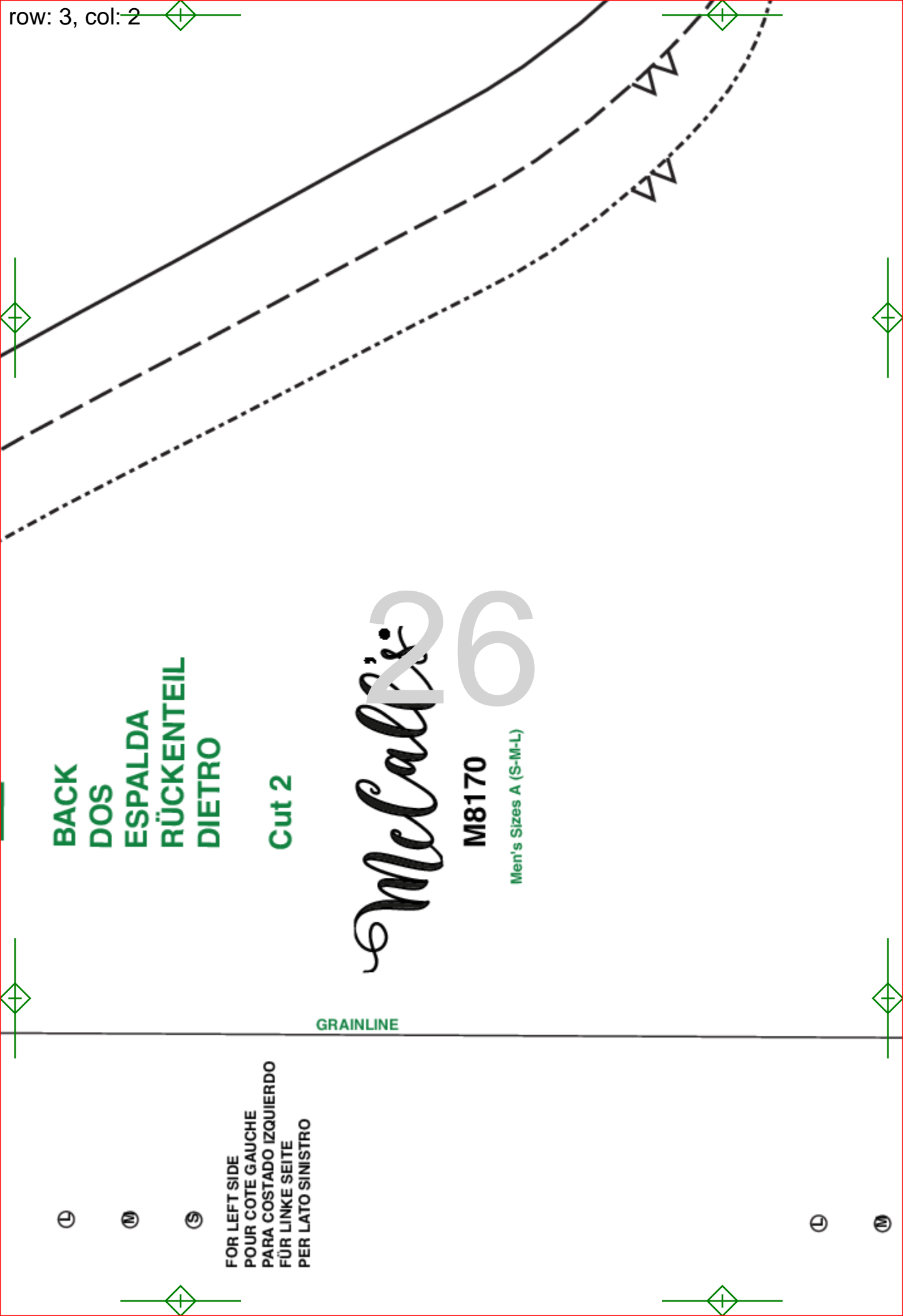



27

LENGTHEN OR SHORTEN HERE



Ⓜ

Ⓢ

FOR LEFT SIDE





28





29





30



31

HEM 1 1/4" (3.2 CM)

LENGTHEN OR





32





LENGTHEN OR SHORTEN HERE

33



row: 3, col: 10

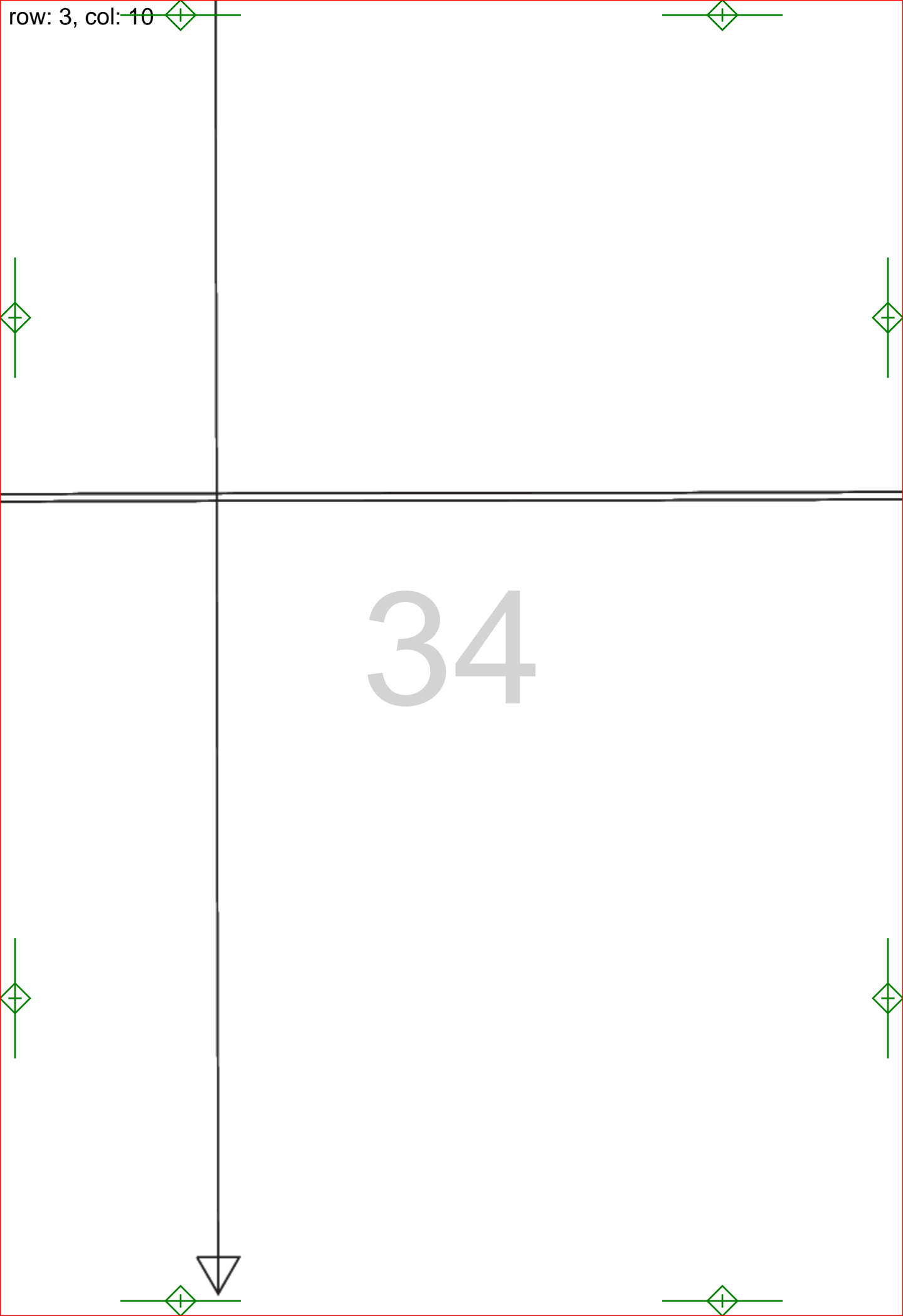

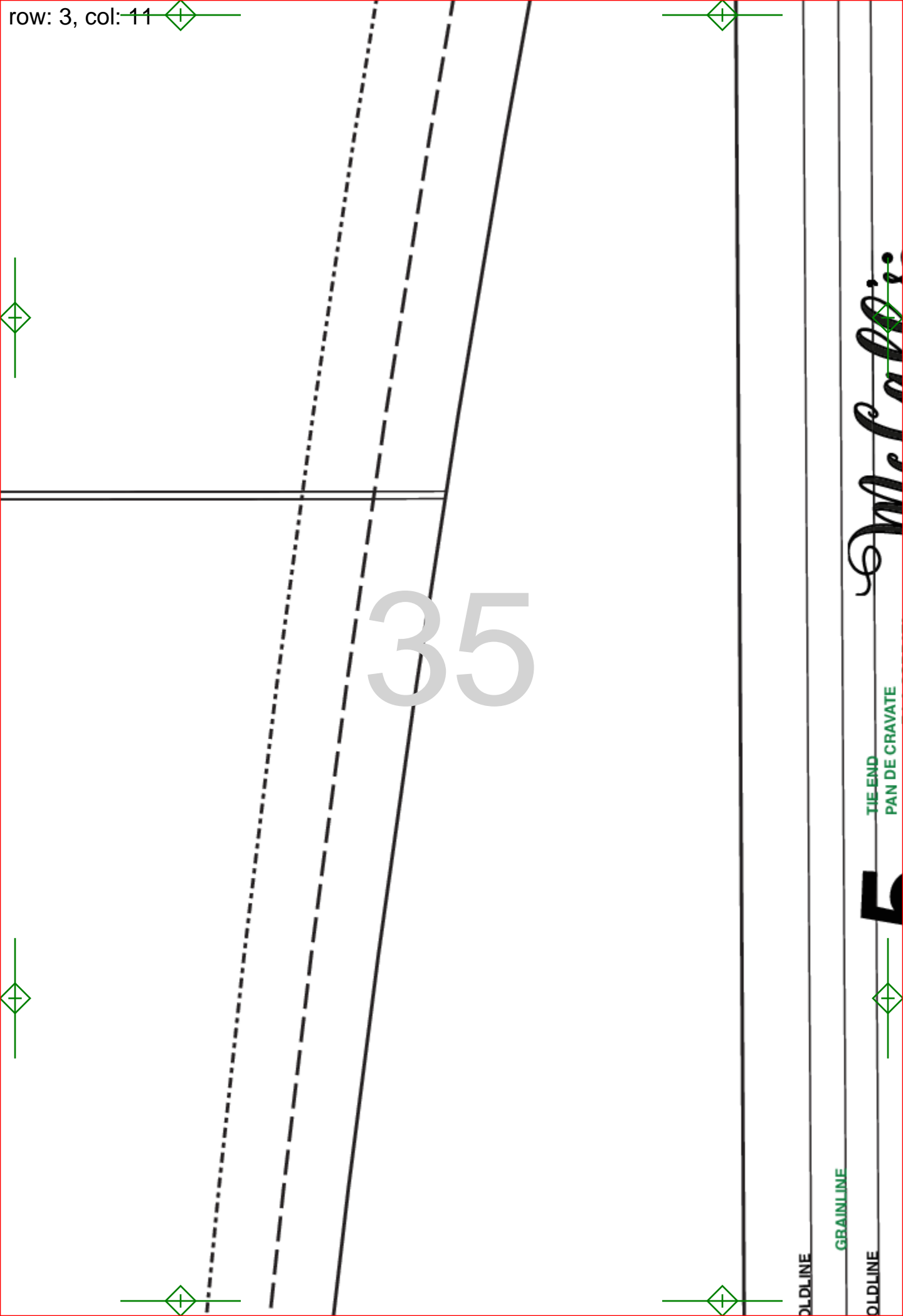

McCall's

TIE-END
PAN DE CRAVATE



OLDLINE

GRAINLINE

OLDLINE

5 *McCall's*

PAN DE CRAVATE
EXTREMO DE LA CORBATA
ENDE
PUNTE CRAVATTA

M 8170

Men's Sizes A (S-M-L)

Cut 6

GUIDE FOR ELASTIC
GUIDE POUR ELASTIQUE
GUIA PARA EL ELASTICO
MARKIERUNGSBAND (GUMMIBAND)
GUIDA PER L'ELASTICO

McCall's

M 8170

Men's Sizes A (S-M-L)

Cut 2



36

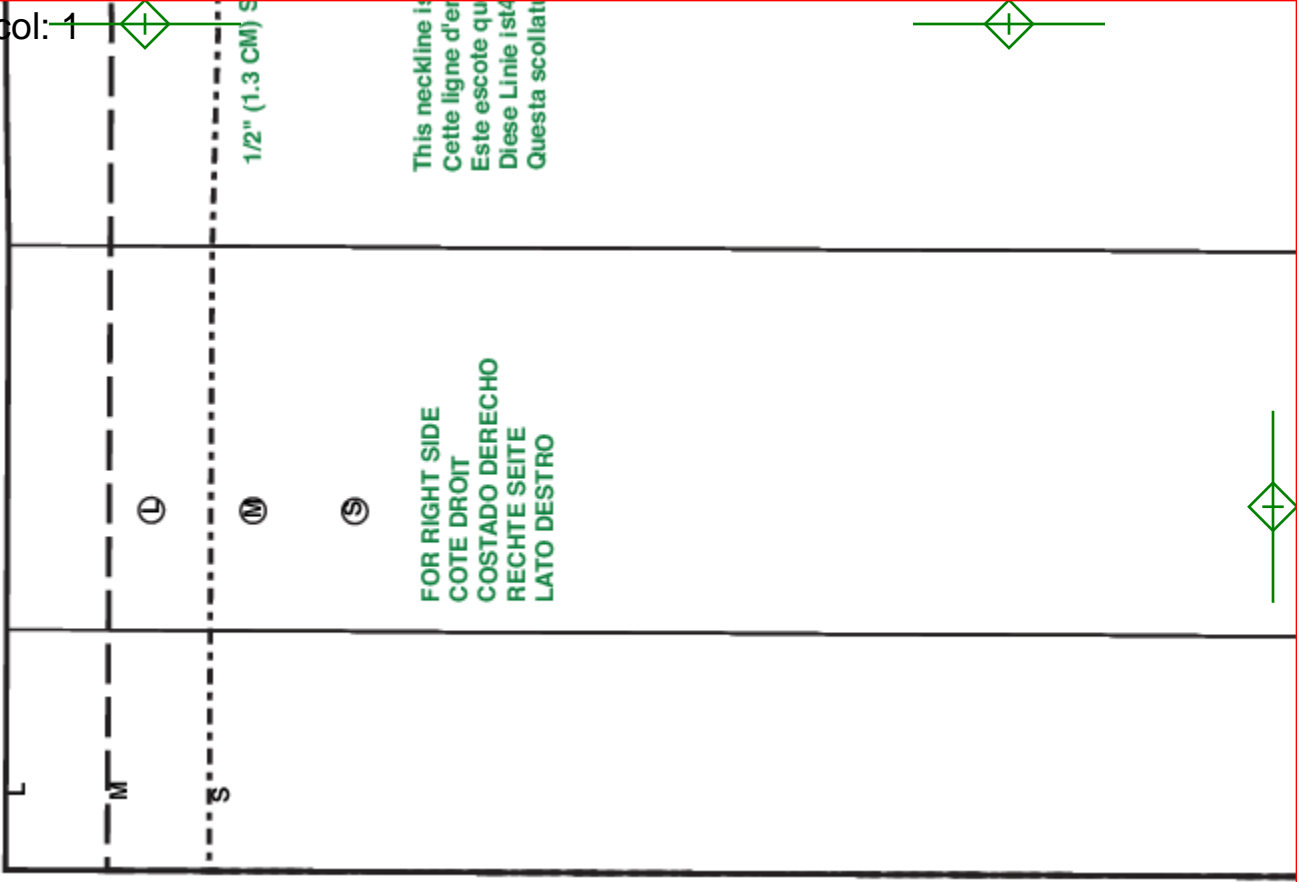

FOR RIGHT SIDE
 COTE DROIT
 COSTADO DERECHO
 RECHTE SEITE
 LATO DESTRO

This neckline is
 Cette ligne d'encolure
 Este escote qu
 Diese Linie ist
 Questa scollat

CENTER BACK

FOR RIGHT SIDE

FOLDLINE

38



WAISTLINE



9

FOR RIGHT SIDE



39





40





41





42





43



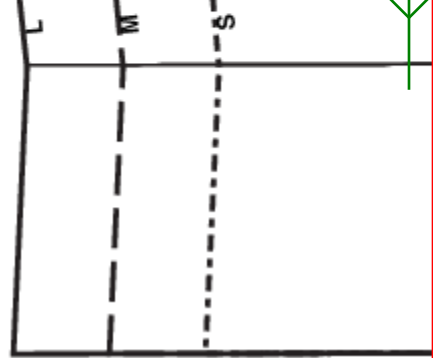

44





FOLDL

45





LDLINE

46



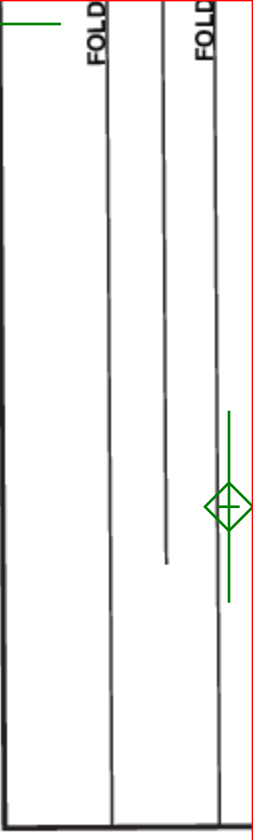
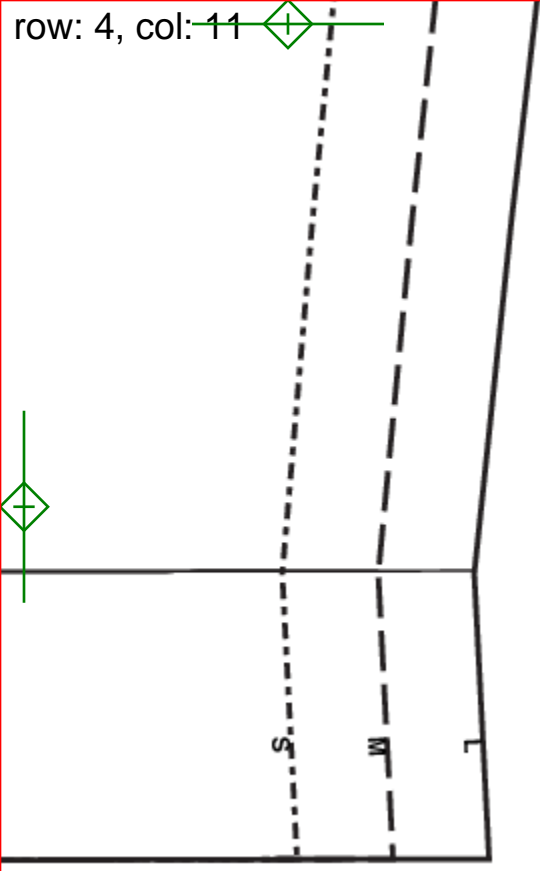

47



FOI

GGMG

4

S
W
1

48